

*Dishwasher
Instruction Manual*

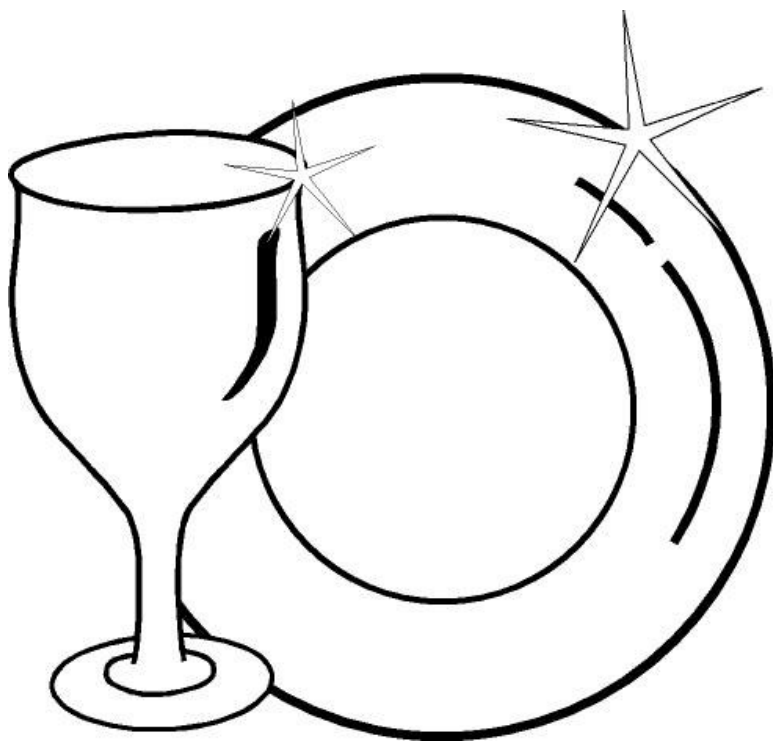

CONTENTS

Getting familiar with your machine	4
• Technical specifications	5
• Conformity with the standards and Test data	5
<i>Safety information and Recommendations.....</i>	5
• Recycling	5
• Safety information	5
• Recommendations	6
• Items not suitable for dishwashing	7
<i>Installing the machine</i>	7
• Positioning the machine	7
• Water connections	7
• Water inlet hose	8
• Water outlet hose	8
• Electrical connection.....	9
• Fitting the machine undercounter	9
• Prior to using the machine	11
<i>Preparing the machine for use</i>	11
• The importance of water decalcification	11
• Filling with salt	11
• Testing strip.....	12
• Adjusting salt consumption.....	12
• Detergent usage	14
• Filling the detergent compartment.....	14
• Combined detergent	14
• Filling with rinse aid and making the setting.....	15

Loading your dishwasher	16
• Dish rack	16
• Alternative basket loads	18
• Standard loading and test data	19
Programme descriptions	20
• Programme items	20
Switching on the machine and selecting a programme.....	21
• Switching on the machine.....	21
• Programme follow-up.....	21
• Changing a programme	21
• Changing a programme with resetting	22
• Switching the machine off	22
Maintenance and Cleaning	23
• Filters	23
• Spray arms	24
• Hose filter	24
Failure codes and what to do in case of failure	25
Practical and useful information.....	27

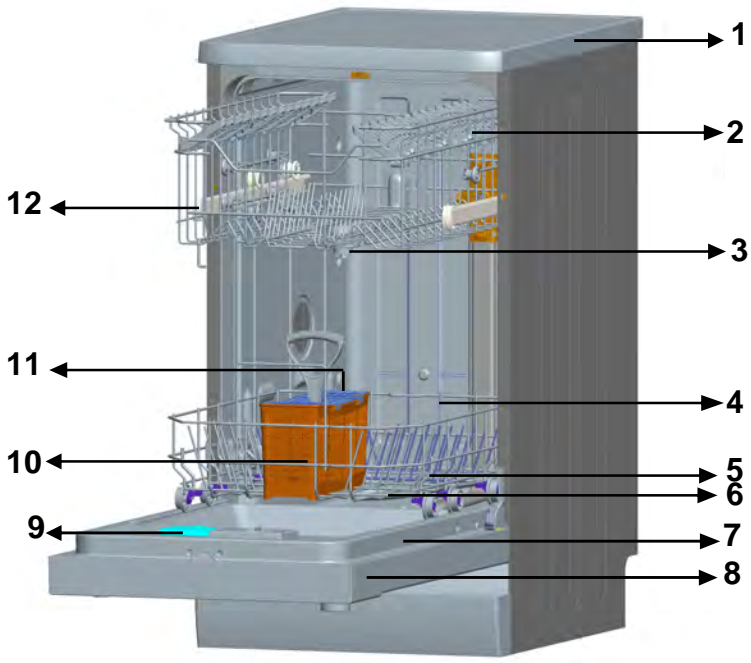

- | | | | |
|----|-------------------------|-----|-----------------------------------|
| 1. | Worktop | 7. | Rating plate |
| 2. | Upper basket with racks | 8. | Control Panel |
| 3. | Upper spray arm | 9. | Detergent and rinse-aid dispenser |
| 4. | Lower basket | 10. | Cutlery basket |
| 5. | Lower spray arm | 11. | Salt dispenser |
| 6. | Filters | 12. | Upper basket track latch |

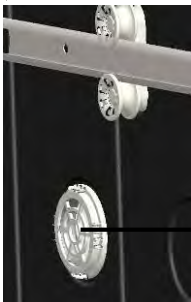

13 Active Drying Unit: This system provides better drying performance for your dishes.

GETTING FAMILIAR WITH YOUR MACHINE

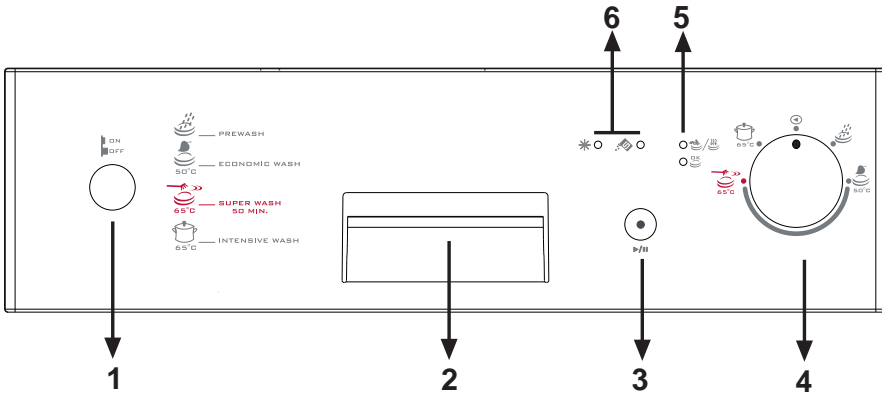

1.) Power On/Off Button

When the power on/off button is pressed, the lamp on the Start /Pause starts lighting.

2.) Door Handle

The door handle is used to open/close the door of your machine.

3.) Start / Pause Button

Once you press the Start/Pause button, the programme you selected with the programme selector button will start running and the status indicator lamp "wash/Dry" will light up. In the stop condition while wash led is On, Start/Pause led will blink.

4.) Programme Selector Knob

With the programme selector knob, you can select a suitable programme for your dishes.

5.) Wash/Dry - End of cycle indicator

You can monitor the programme status with the help of "wash/dry" and "end" indicators.

- . Wash/Dry
- . End

6.) Salt Lack Warning Indicator

In order to see whether softening salt in your machine is sufficient or not, check salt lack warning lamp on the display. When salt lack warning lamp starts coming on, you need to fill in the salt chamber.

Rinse Aid Lack Warning Indicator

In order to check that there is sufficient rinse aid in your machine, check rinse aid lack warning lamp on the display. When rinse aid lack warning lamp starts coming on, fill in rinse aid chamber.

Technical specifications

Capacity	10 place settings
Height	845 mm
Height (without worktop)	815 mm
Width	450 mm
Depth	598 mm
Net Weight	40 kg
Electricity input	220-240 V, 50 Hz
Total Power	1900 W
Heating Power	1800 W
Pump Power	100 W
Drain Pump Power	30 W
Water supply pressure.....	0.03 MPa (0,3 bar) - 1 MPa (10 bar)
Current	10 A

- Producer company has its right to amend design and technical specifications reserved.
- The machine's service life is 10 years (the duration required to keep spare parts for the machine to fulfil its usage functions).

Conformity with the standards and Test data / EC Declaration of Conformity

All stages related to the machine are executed in accordance with the safety rules provided in all relevant directives of the European Community.

2004/108/EC, 2006/95/EC, IEC 436/DIN 44990, EN 50242

SAFETY INFORMATION AND RECOMMENDATIONS

Recycling

- Certain components and the packaging of your machine have been produced from recyclable materials.
- Plastic parts are marked with international abbreviations:
(>PE< , >PS< , >POM<, >PP<,)
- Cardboard parts have been produced from recycled paper and they should be disposed of into waste paper collection containers for recycling.
- Such materials are not suitable for being disposed of into garbage bins. They should be delivered to recycling centres instead.
- Contact relevant centres in order to obtain information on methods and points of disposal.

Safety Information

When you take delivery of your machine

- Check for any damage to your machine or to its packaging.
Never start a machine damaged in any way, make sure to contact an authorised service.
- Unwrap the packaging materials as indicated and dispose of them in accordance with the rules.

The points to pay attention during machine installation

- Choose a suitable, safe and level place to install your machine.
- Carry out the installation and connection of your machine by following the instructions.
- This machine should be installed and repaired by an authorised service only.

- Only original spare parts should be used with the machine.
- Before installing, be sure that the machine is unplugged.
- Check whether the indoor electrical fuse system is connected according to the regulations.
- All electrical connections must match the values indicated on the rating plate.
- Pay special attention and be sure that the machine does not stand on the electricity supply cable.
- Never use an extension cord or a multiple socket for making a connection. The plug should be comfortably accessible after the machine has been installed.
- After installing the machine to a suitable place, run it unloaded for the first time.

In daily use

- This machine is for household use, do not use it for any other purpose. Commercial usage of the dishwasher will void the guarantee.
- Do not load your machine above its capacity; wash in the machine only those items which are suitable for dishwashing.
- Do not get up, sit or place a load on the open door of the dishwasher, it may fall over.
- Never put into the detergent and rinse aid dispensers of your machine anything other than those detergents and rinse aids which are produced specifically for dishwashers. Our company will not be responsible for any damage that might occur in your machine otherwise.
- The water in the machine's washing section is no drinking water, do not drink it.
- Due to danger of explosion, do not put into the machine's washing section any chemical dissolving agents such as solvents.
- Check whether plastic items are heat-resistant before washing them in the machine.
- Do not put into your machine those items which are not suitable for dishwashing. Also, do not fill any basket above its capacity. Our company will not be responsible for any scratch or rust to form on the inner frame of your machine due to basket movements otherwise.
- Especially because hot water may flow out, the machine door should not be opened under any circumstances while the machine is in operation. In any case, a safety device ensures that the machine stops if the door is opened.
- Do not leave your dishwasher's door open. Failure to do so may lead to accidents.
- Place knives and other sharp-ended objects in the cutlery basket in blade-down position.
- This appliance is not intended for use by persons (including children) with reduced physical, sensory or mental capabilities, or lack of experience and knowledge, unless they have been given supervision or instruction concerning use of the appliance by a person responsible for their safety

For your children's safety

- After removing the machine's packaging, make sure that the packaging material is out of reach of children.
- Do not allow children to play with or start the machine.
- Keep your children away from detergents and rinse aids.
- Keep children away from the machine while it is open because there may still be residues of cleaning substances inside the machine.
- Be sure that your old machine does not pose any threat to your children. Children are known to have gotten themselves locked in old machines. To forestall such a situation, break your machine's door lock and tear off the electrical cables.

In case of malfunctioning

- Any malfunction in the machine should be repaired definitely by qualified persons. Any repair work performed by anyone other than the authorised service personnel will cause your machine to be left outside the scope of warranty.
- Prior to any repair work on the machine, be sure that the machine is cut off from the mains. Switch off the fuse or unplug the machine. Do not pull by the cable when unplugging. Make sure to turn off the water tap.

Recommendations

- For energy and water saving, remove coarse residues on your dishes before placing the dishes into the machine. Start your machine after having fully loaded it
- Use the pre-wash programme only whenever necessary.
- Place such hollow items as bowls, glasses and pots into the machine in such a way that they will face down.
- You are recommended not to load into your machine any dishes different or more than indicated.

Items not suitable for dishwashing:

- Cigarette ashes, candle leftovers, polish, chemical substances, iron-alloy materials;
- Forks, spoons and knives with wooden or bone, or ivory or nacre-coated handles; glued items, paint, items soiled with abrasive, acidic or base chemicals
- Plastic items that are not heat-resistant, copper or tin-coated containers;
- Aluminium and silver objects (they may discolour, become dull)
- Certain delicate glass types, porcelains with ornamental printed patterns as they fade even after the first wash; certain crystal items as they lose their transparency over time, adhered cutlery that is not heat-resistant, lead crystal glasses, cutting boards, items manufactured with synthetic fibre;
- Absorbent items as sponges or kitchen rags are not suitable for dishwashing.

Warning: Take care to buy dishwasher-proof sets in your future purchases.

INSTALLING THE MACHINE

Positioning the machine

When determining the place to put your machine on, take care to choose a place where you can easily load and unload your dishes.

Do not put your machine in any location where there is the probability for the room temperature to fall below 0°C.

Before positioning, take the machine out of its packaging by following the warnings located on the package.

Position the machine close to a water tap or drain. You need to site your machine, taking into consideration that its connections will not be altered once they are made.

Do not grip the machine by its door or panel in order to move it.

Take care to leave a certain clearance from all sides of the machine so that you can comfortably move it back and forth during cleaning.

Make sure that the water inlet and outlet hoses do not get squeezed while positioning the machine. Also, make sure that the machine does not stand on the electrical cable.

Adjust the machine's adjustable feet so that it can stand level and balanced. Proper positioning of the machine ensures problem-free opening and closing of its door.

If the door of you machine does not close properly, check if the machine is stable on the floor it stands; if not, adjust the adjustable feet and ensure its stable position.

Water connection

Be sure that the indoor plumbing is suitable for installing a dishwasher. Also, we recommend that you fit a filter at the entrance of your place or apartment so as to avoid any damage to your machine because of any contamination (sand, clay, rust etc.) that might be occasionally carried in through the mains water supply or the indoor plumbing, and to forestall such complaints as yellowing and formation of deposits after washing.



Water inlet hose

Do not use the water inlet hose of your old machine, if any. Use the new water inlet hose supplied with your machine instead. If you are going to connect a new or long-unused water inlet hose to your machine, run water through it for a while before making the connection. Connect the water inlet hose directly to the water inlet tap. The pressure supplied by the tap should be at a minimum of 0.03 Mpa and at a maximum of 1 Mpa. If the water pressure is above 1 Mpa, a pressure-relief valve should be fitted inbetween. After the connections are made, the tap should be turned on fully and checked for water tightness.

For the safety of your machine, make sure to always turn off the water inlet tap after each wash programme is finished.

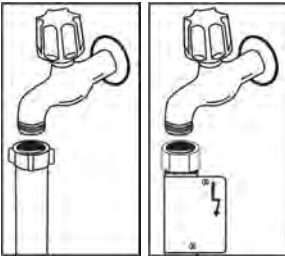

NOTE: Aquastop water spout is used in some models. In case of using Aquastop, a dangerous tension exists. Do not cut Aquastop water spout. Do not let it get folded or twisted.

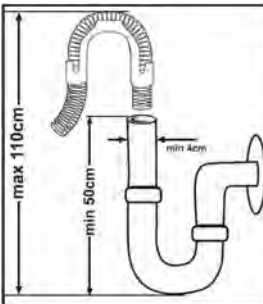

Water outlet hose

The water drain hose can be connected either directly to the water drain hole or to the sink outlet spigot. Using a special bent pipe (if available), the water can be drained directly into the sink via hooking the bent pipe over the edge of the sink.

This connection should be at a minimum of 50 cm and at a maximum of 110 cm from the floor plane.

Warning: When a drain hose longer than 4 m is used, the dishes might remain dirty. In that case, our company will not accept responsibility.

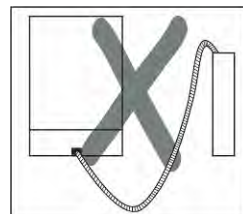
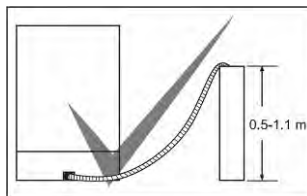

Electrical connection

The earthed plug of your machine should be connected to an earthed outlet supplied by suitable voltage and current. If there is no earthing installation, have a competent electrician carry out an earthing installation. In case of usage without earthing installed, our company will not be responsible for any loss of usage that might occur.

The indoor fuse current value should be 10-16 A.

Your machine is set according to 220-240 V. If the mains voltage in your location is 110 V, connect a transformer of 110/220 V and 3000 W inbetween. The machine should not be plugged in during positioning.

At low voltage, Wash efficiency of your machine decreases.

Always use the coated plug supplied with your machine.

The machine's electrical cable should be replaced by an authorised service or an authorised electrician only. Failure to do so may lead to accidents.

For safety purposes, always make sure to disconnect the plug when a wash programme is finished.

In order not to cause an electric shock, do not unplug when your hands are wet.

When disconnecting your machine from the mains supply, always pull from the plug. Never pull the cord itself.

Fitting the machine undercounter

If you wish to fit your machine undercounter, check whether you have sufficient space under your countertop and whether the wiring-plumbing is suitable to do so. **1** If you decide that the space under the countertop is suitable for fitting your machine, remove the worktop as shown in the illustration. **2**

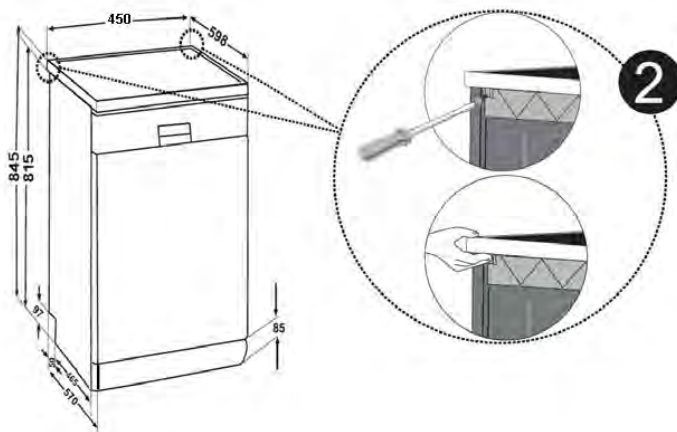

Warning: The stand part which we will settle our machine under it by removing its worktop has to be stable in such a way not to allow balance disorder.

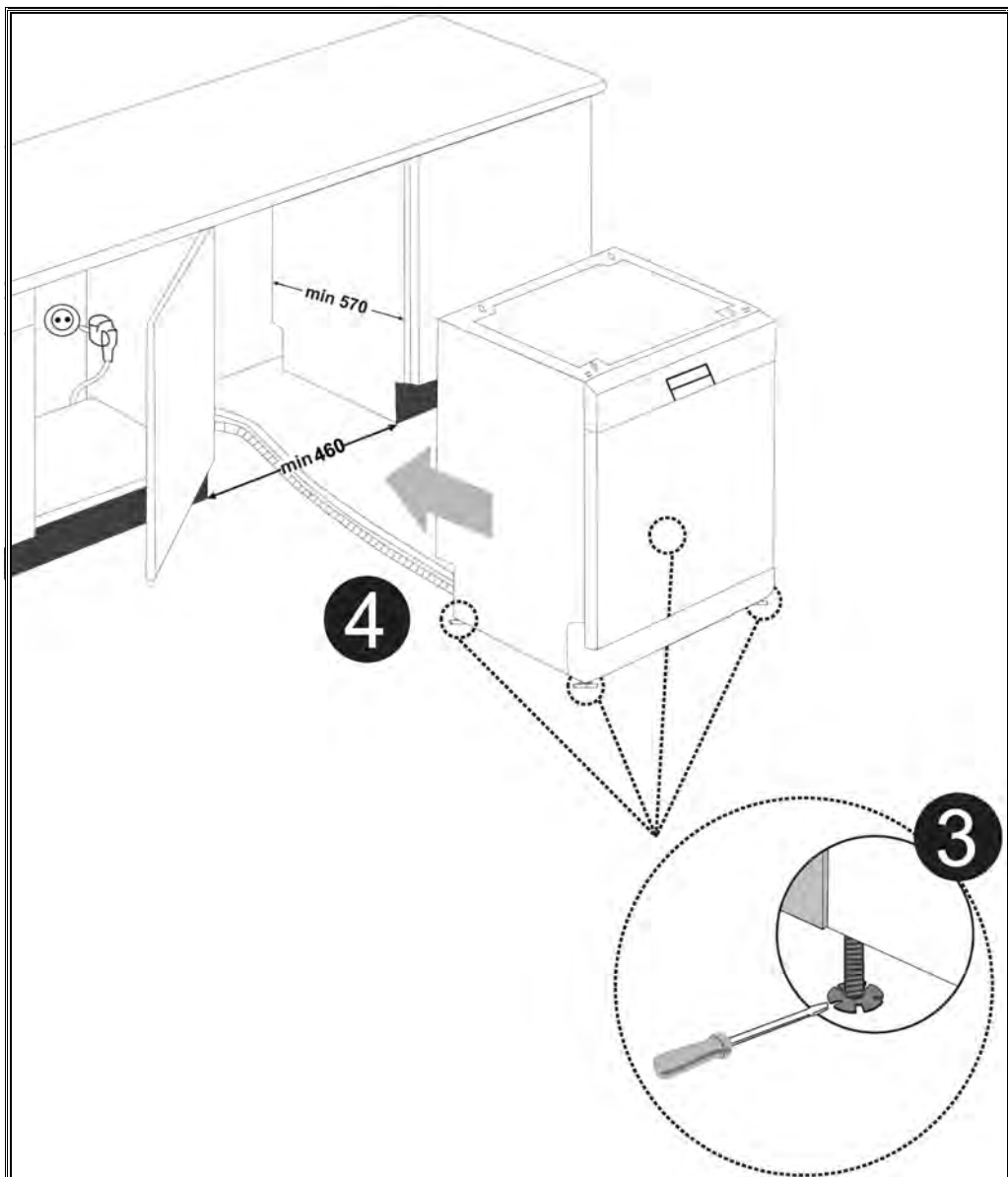

To remove the worktop, remove the screws that hold the worktop which are located at the rear of the machine; then push the front panel 1 cm from the front side towards the rear and lift it.

Adjust the machine feet according to the slope of the floor. **3** Fit your machine by pushing it undercounter without letting the hoses get crushed or bent. **4**

Warning: After removal of worktop, the machine should be placed in such a closed place of which dimensions are shown at fig.

Prior to using the machine for the first time

- Check whether the electricity and supply water specifications match the values indicated by the installation instructions for the machine.
- Remove all packaging materials inside the machine.
- Set the water softener.
- Add 1 kg salt into the salt compartment and fill with water up to a level at which it will almost overflow.
- Fill the rinse aid compartment.

PREPARING THE MACHINE FOR USE

The importance of water decalcification

For a good washing function, the dishwasher needs soft, i.e. less calcareous water. Otherwise, white lime residues will remain on the dishes and the interior equipment. This will negatively affect your machine's washing, drying and shining performance. When water flows through the softener system, the ions forming the hardness are removed from the water and the water reaches the softness required to obtain the best washing result. Depending on the level of hardness of the inflowing water, these ions that harden the water accumulate rapidly inside the softener system. Therefore, the softener system has to be refreshed so that it operates with the same performance also during the next wash. For this purpose, dishwasher salt is used.

Filling with salt

Use softener salt specifically produced for use in dishwashers. To put softener salt, first remove the lower basket and then open the salt compartment cap by turning it counter clockwise. At first fill the compartment with 1kg salt and water up to overflowing level. If available, using the funnel provided will make filling easier; refit the cap and close it. When salt absent indicator is lighten on (app. between 20th-30th cycles depend on the water hardness) add salt into your machine until it fills up (approx. 1 kg) **Fill the salt compartment with water at first use** only. We recommend that you use small- grained or powder softener salt. Do not put table salt into your machine. Otherwise, the function of the softener compartment may decrease over time. When you start your dishwasher, the salt

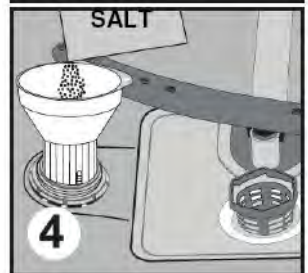
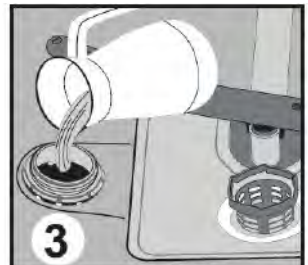
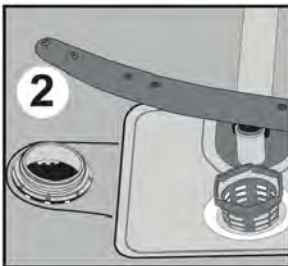
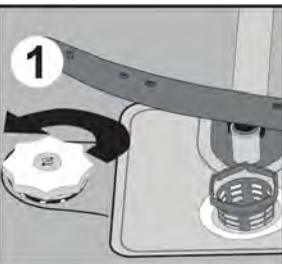

compartment gets filled with water. Therefore, put the softener salt prior to starting your machine. This way, overflowing salt gets immediately cleaned up through the wash operation. If you are not going to wash any dishes immediately after putting salt, then run a short washing program with an empty machine in order to avoid any damage (to prevent corrosion) to your machine due to the salt overflow while filling in the salt container.

Testing strip

The washing effectiveness of your machine depends on the softness of the tap water. For this reason, your machine is equipped with a system that reduces the hardness in mains water supply. The washing effectiveness will increase when the system is correctly set. To find out the water hardness level of water in your area, contact your local water board or determine water hardness level by using the test strip(if available).

Open the testing strip.	Run water through your tap for 1 min.	Keep the testing strip in water for 1 sec.	Shake the testing strip after taking it out of water.	Wait for 1 min.	Make your machine's water hardness setting according to the result obtained through the testing strip.
-------------------------	---------------------------------------	--	---	-----------------	--

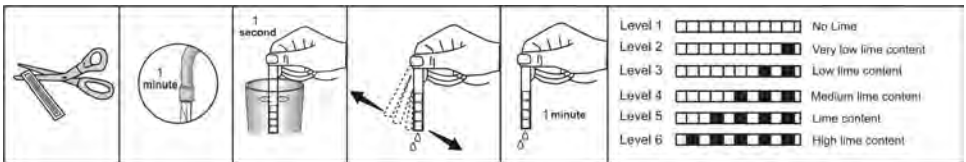

Adjusting salt consumption

Table of Water Hardness Level Settings

Water hardness level	German hardness dH	French hardness dF	British hardness dE	Hardness Level Indicator
1	0-5	0-9	0-6	<ul style="list-style-type: none"> ● Wash/Dry lamp is on. ○ End lamp is off ○ The Start/Pause lamp is off.
2	6-11	10-20	7-14	<ul style="list-style-type: none"> ○ Wash/Dry lamp is off. ● End lamp is on. ○ The Start/Pause lamp is off.
3	12-17	21-30	15-21	<ul style="list-style-type: none"> ○ Wash/Dry lamp is off. ○ End lamp is off. ● The start/Pause lamp is on.
4	18-22	31-40	22-28	<ul style="list-style-type: none"> ● Wash/Dry lamp is on. ● End lamp is on. ○ The start/Pause lamp is off.
5	23-34	41-60	29-42	<ul style="list-style-type: none"> ● Wash/Dry lamp is on. ○ End lamp is off. ● The start/Pause lamp is on.
6	35-50	61-90	43-63	<ul style="list-style-type: none"> ○ Wash/Dry lamp is off. ● End lamp is on. ● The start/Pause lamp is on.

If the hardness of the water you use is above 90 dF (French hardness) or if you are using well water; you are recommended to use filter and water refinement devices.

NOTE: Hardness level is adjusted to level 3 as a factory setting.

Adjusting salt consumption

Adjust the water softener according to how hard your tap water is.

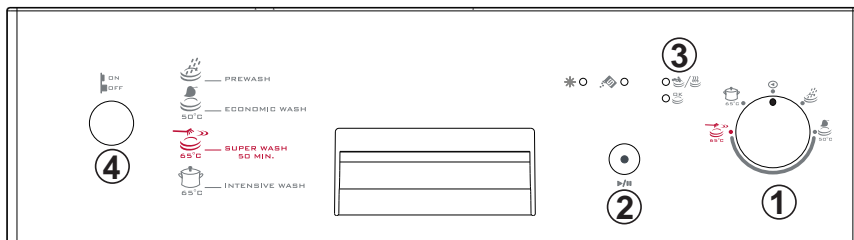

Move the programme selector knob to the 0 (Reset) position while your machine is not in operation. **1**



After resetting your machine, press the Start/Pause button and keep it pressed down. **2**



Meanwhile, energise the machine by pressing the Power On/Off button. **4**



Keep Start/Pause keys press until program monitor lights are on and off. **2**



After the lamps "Wash/Dry/End" have flashed **3**, release the Start/Pause button. **2**

Your machine displays the latest entered water hardness setting.



You can adjust the levels by pressing the Start/Pause button **2** according to *Table of Water Hardness Level Settings*.



After adjusting the water hardness level, press on/off button to save the settings in memory. **4**

Detergent usage

Use a detergent specifically designed for use in domestic dishwashers. You can find powder, gel, and tablet detergents in the market that have been designed for household dishwashers.

Detergent should be put into the compartment prior to starting the machine. Keep your detergents in cool, dry places out of reach of your children.

Do not fill detergent into the detergent compartment more than required; otherwise it may cause scratches on your glasses as well as lead to a poorly dissolved detergent.

Should you need more information concerning the detergent you will use, contact detergent manufacturers directly.

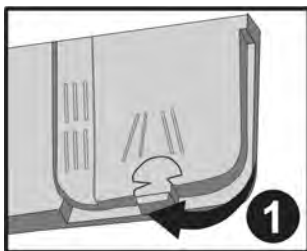

Filling the detergent compartment

Push the latch to open the detergent container as shown in the image. Detergent pod has level lines inside. It is possible to measure the right detergent amount using these lines.

Detergent pod can take totally 40 cm³ detergent.

Open the dishwasher detergent and pour into the larger compartment **a** 25 cm³ if your dishes are heavily soiled or 15 cm³ if they are less soiled.

2 If your dishes have been kept dirty for a very

long time, if there are dried food wastes on them, and if you have overly loaded the dishwasher, pour **a** 5cm³ detergent into the pre-wash compartment and start your machine.

You may have to add more detergent into your machine, depending on the degree of soil and on the water hardness level in your area.



Combined detergents

Detergent manufacturers also manufacture combined detergents that are called 2 in 1 – 3 in 1- 5 in 1...

The 2 in 1 detergents contain detergent+ salt or rinse aid . While using the 2 in 1 detergents, it should be observed which functions the tablet consists of.

The other tablet detergents also have detergent+rinse aid +salt+various extra functions.

Generally, combined detergents produce sufficient results under certain usage conditions only. Such detergents contain rinse aid and/or salt in preset amounts.

Points to consider when using this type of products:

- Always make sure to check the specifications of the product you will use or whether or not it is a combined product.
- Check if the detergent used is appropriate for the hardness of mains water that machine is pertaining to.
- Observe the instructions on packagings when using such products.

- If such detergents are in the form of tablets, never put them into the interior section or the cutlery basket of the dishwasher. Always put the tablets into the detergent compartment in the detergent dispenser.
- They produce good results for certain types of usage only. If you are using this type of detergents, you need to contact the manufacturers and find out about the suitable conditions of use.
- When the conditions of use of such products and the machine settings are appropriate, they ensure savings in salt and/or rinse aid consumption.
- Contact the detergent manufacturers if you are not obtaining good wash results (if your dishes stay calcareous and wet) after having used 2 in 1 or 3 in 1 detergents. The scope of warranty for your machine does not cover any complaints caused by the use of these types of detergents.

Recommended usage: If you want to obtain better results while using combined detergents, add salt and rinse aid into your machine and adjust the water hardness setting and the rinse aid setting to the lowest position.

 Solubility of the tablet detergents produced by different companies can vary depending on the temperature and time. Therefore, it is not recommended to use such detergents in short programs. It is more suitable to use powder detergents in such programs.

Warning: Should any problem, which you have not encountered before, arise with the use of this type of detergents, contact the detergent manufacturers directly.

When you give up using combined detergents

- Fill the salt and rinse aid compartments.
- Adjust the water hardness setting to the highest position and run an empty-wash.
- Adjust the water hardness level.
- Make the suitable rinse aid setting.

Filling with rinse aid and making the setting.

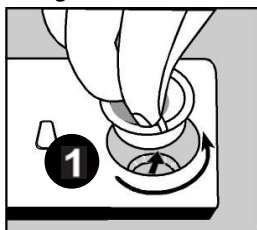



material produced for use at dishwashers should be used.

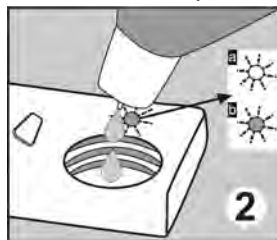

Rinse aid is used to prevent the stay of white water drops, lime stains, white film strip-shaped stains that may form on the dishes, as well as to increase the drying performance. Contrary to the popular beliefs, it is used not only for obtaining shinier dishes but also for obtaining sufficiently dried dishes. For this reason, care should be taken that there is adequate amount of rinse aid in the rinse aid compartment and only polishing



To put rinse aid, remove the rinse aid compartment cap by turning it.  Fill the rinse aid compartment with rinse aid until the rinse aid level indicator becomes dark; refit the cap and close it by turning it in a way that the nails will correspond to one another. By checking the rinse aid level indicator on the detergent dispenser, you can understand whether or not your machine needs rinse aid. A dark indicator  means that there is rinse aid in the compartment, while a light indicator  shows that you need to fill the compartment with rinse aid.

The rinse aid level adjuster can be set to a position between 1 and 6. Factory setting for rinse aid is the position 3.

You need to increase the degree of the adjuster if water stains form on your dishes after a wash, whereas you need to decrease the degree if a blue stain is left when wiped by hand.

Warning: Use only those rinse aid materials which are allowed for use in the machine. As rinse aid residues left as a result of overflowing will create extremely high amounts of foam and thus reduce the washing performance, remove the excess amount of rinse aid by wiping it with a rag.

LOADING YOUR DISHWASHER

If you properly place your dishes into the machine, you will be using it in the best way in terms of energy consumption, washing and drying performance.

There are two separate baskets for you to load your dishes into your machine. You can load into the lower basket such round and deep items as pots with long handles, pot lids, plates, salad plates, cutlery sets.

The upper basket has been designed for tea plates, dessert plates, salad bowls, cups and glasses. When placing long-stem glasses and goblets, lean them against the basket edge, rack or glass supporter wire and not against other items. Do not lean long glasses against one another or they cannot remain steady and may receive damage.

It is more appropriate to locate the thin narrow parts into the middle sections of baskets.

You can place spoons among the other cutlery sets in order to prevent them from sticking to one another. You are recommended to use the cutlery grid in order to obtain the best result.

To avoid any possible injuries, always place such long-handle and sharp-pointed dishes as serving fork, bread knife etc. with their sharp points facing down or horizontally on the baskets.

Warning: Place your dishes into your machine in a way that they will not prevent the upper and lower spray arms from spinning.

Dish rack

There are dish racks on the upper basket of your machine. **a** **b** You can use these dish racks in open or closed position. When they are in open position **a** you can place your cups on them; and when in closed position **b** you can place long glasses on the basket. Also, you can use these racks by placing long forks, knives and spoons on them laterally.

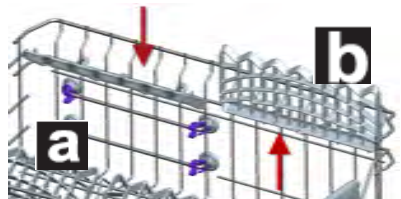

Top basket height adjustment

Top basket of your machine is in upper position. When it is in this position, you can place big items such as pans, etc. on lower basket. When you take top basket to lower position, you can place and wash big sized plates on the top basket.

Use wheels in order to change the basket height. Open the basket retaining parts at the end of top basket rails by turning them to the sides, and take the basket out. Change the position of the wheels; reinstall the basket to the rail, and close basket retainer parts. In this way, you take the top basket to lower position.

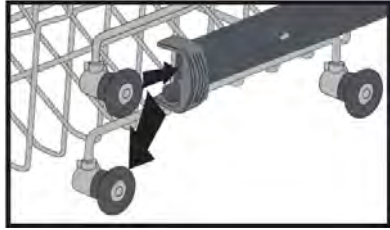
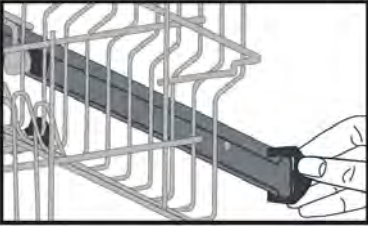

Lower Basket

Folding Racks

Folding racks consisting of two parts that are located on the lower basket of your machine are designed in order to let you place big items easier such as pots, pans, etc. If requested, each part can be folded separately, or all of them can be folded and larger spaces can be obtained. You can use folding racks by raising them upwards, or by folding them down.



Alternative basket loads

Lower Basket



Top basket

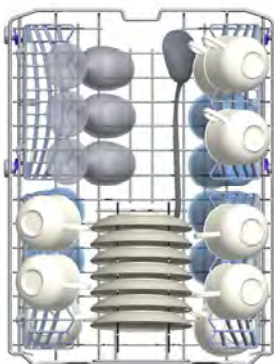

Faulty loads

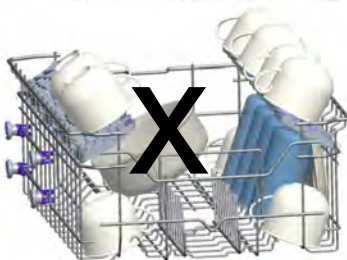
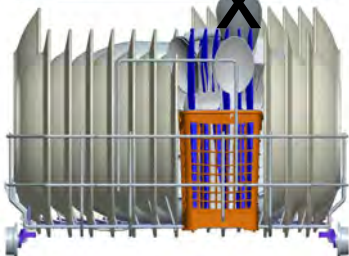
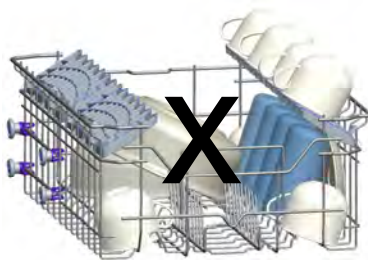
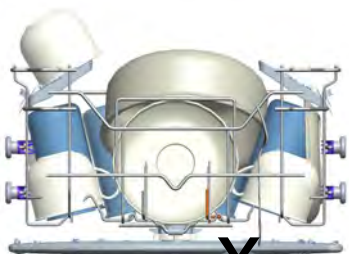

Standard loading and test data

Capacity:

Upper and lower baskets: 10 place settings. The upper basket should be adjusted to lower position.

Detergent / Rinse aid

5+20 cm³, in accordance with EN50242-DIN 44990 IEC 436 (international norms) / Rinse aid dosage adjustment: 4

Programme test

Economic 50 °C, in accordance with EN 50242 (international norms)

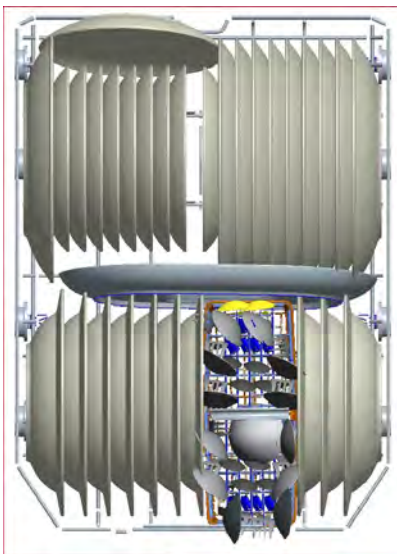
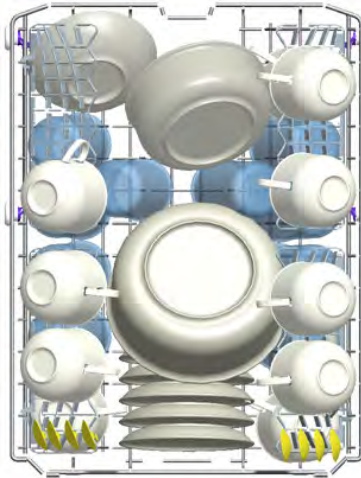

3	1		8	1	3
2	3	3	3	3	2
1	4	4	4	4	1
2		4		4	2
1					1
2					2
1		4	6	4	1
2	4		4		2
1	3	3	3	3	1
7	2	5	5	2	7



PROGRAMME DESCRIPTIONS

Programme items

Programme No	Prewash	Economic (Reference)	Super Wash 50 min.	Intensive
Programme names and temperatures	-	50°C	65°C	65°C
Type of food waste	Pre-wash to rinse and loosen residue-awaiting full load-then select a programme	coffee,milk,tea,cold meats,vegetables ,not kept for long	soups, sauces, pasta, eggs, pilaf, potato and oven dishes, fried foods	soups, sauces, pasta, eggs, pilaf, potato and oven dishes, fried foods
Level of soil	-	medium	medium	high
Detergent amount A: 25 cm ³ / 15 cm ³ B: 5 cm ³	-	A+B	A+B	A+B

```

    graph TD
      Prewash --> End1[End]
      Prewash --> Wash50[50°C Wash]
      Prewash --> Wash65[65°C Wash]
      Prewash --> Wash65_2[65°C Wash]
      
      End1 --> Rinse50[Cold rinse]
      Wash50 --> Rinse50
      
      Rinse50 --> Rinse50_2[Hot rinse]
      Wash65 --> Rinse50_2
      
      Rinse50_2 --> Dry1[Dry]
      Wash65 --> Dry1
      
      Dry1 --> End2[End]
      
      Rinse50_2 --> Rinse65[Cold rinse]
      Wash65_2 --> Rinse65
      
      Rinse65 --> Rinse65_2[Intermediate rinse]
      Rinse65_2 --> Rinse65_3[Hot rinse]
      Rinse65_3 --> Dry2[Dry]
      Dry2 --> End3[End]
  
```

Programme duration (min.)	15	160	50	115
Electricity consumption (kW hours)	0,02	0,93	1,31	1,45
Water consumption (liters)	3,8	13,6	10,5	17,6

Warning : Short programs do not include a drying step.

The values declared above are the values obtained under laboratory conditions according to relevant standards. These values can change depending on conditions of product's use and environment (network tension, water pressure, water input temperature and environment temperature).

SWITCHING ON THE MACHINE AND SELECTING A PROGRAMME

Switching on the machine

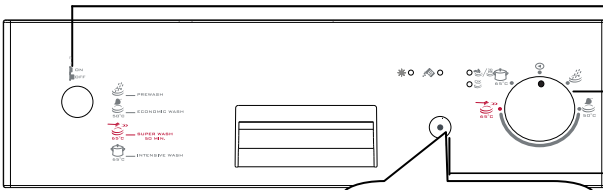

1. Press the Power On/Off key.
2. Select the program suiting your dishes via the Program Selection button.
3. Start the program pressing the Power Start/Pause key.

Once the Power On/Off key is pressed, the lamp Power Start/Pause is highlighted.

The lamp on Program Start/Pause key goes off once the Program starts and the washing/Drying lamp is highlighted.

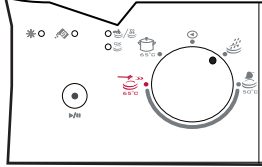

Program follow-up

You can follow the program flow using the program follow-up lamps located on the control panel.

As long as Washing and Drying goes on the Washing/Drying lamp goes on to light. When drying is active machine stays silent about 40-50 minutes

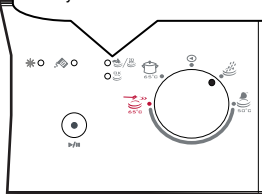

Do not open the cover before the lamp Finished is on.

Once the program is over, the lamp Finished is illuminated.

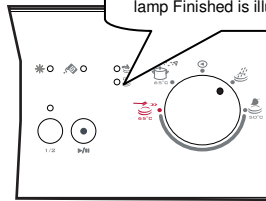

Changing a programme

If you would like to change programs while a washing program is continuing.

Press once the Power Start/Pause key.

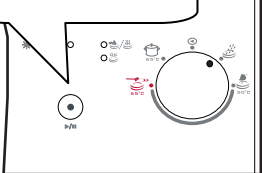

After the program stops, select your desired program via the Program selection button.

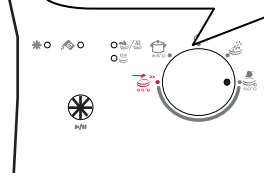

Start the program you have newly selected by pressing again the Start/Pause key.

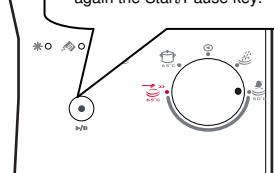

Changing a programme with resetting

If you would like to cancel a program while a washing program is resumed

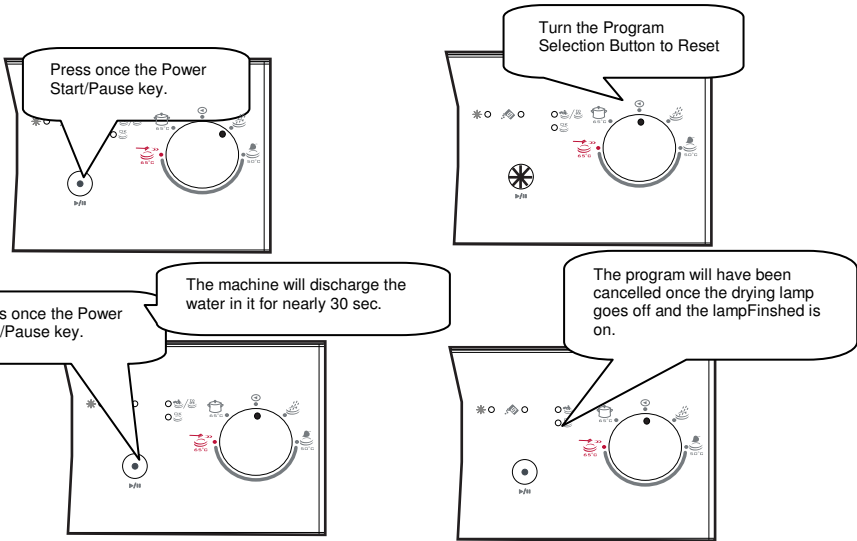

Switching the machine off

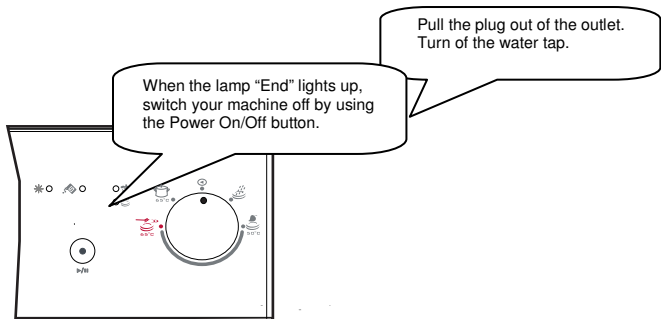

Note: You can slightly open the door in order for the machine to perform a faster dry operation after the wash programme is finished.

Note: If the machine door opens during washing or the power is cut off, the machine will go on to the program in case the door is shut or the power is back.

Note: If energy is cut or machine door is opened during drying process, program is terminated. Your machine becomes ready for new program selection.

MAINTENANCE AND CLEANING

Cleaning the machine in regular intervals prolongs the machine's service life.

Oil and lime may accumulate in the machine's washing section. In case of such accumulation;

-Fill the detergent compartment without loading any dishes into the machine, select a programme that runs at high temperature, and start the machine. In case of insufficiency, use special cleansing material available in the market. (Cleansing material produced special to machines by detergent producers.)

Cleaning the seals in the machine door,

-To clean any accumulated residues in the door seals, wipe the seals regularly by using a dampened cloth.

Cleaning machine,

Clean the filters and spray arms at least once a month.

Unplug your machine and turn off its tap before starting the cleaning.

Do not use hard materials when cleaning your machine. Wipe with a fine cleaning material and a dampened cloth.

Filters

Check if any food wastes have remained on the coarse and fine filters.

If any food wastes are left, remove the filters and clean them thoroughly under the water tap.

- a. Micro Filter
- b. Coarse Filter
- c. Metal/Plastic Filter



To remove and clean the filter combination, turn it counter clockwise and take it out by lifting upwards. **1**

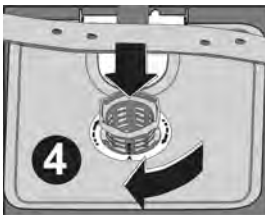

Pull and remove the metal/plastic filter. **3** Then pull the coarse filter out of the micro filter. **2** Rinse it with lots of water under the tap. Refit the metal/plastic filter. Insert the coarse filter into the micro filter in a way that the marks will correspond to one another. Attach micro filter into the metal/plastic filter and turn to the direction of arrow and it is locked when the arrow on micro filter can be seen from across. **4**

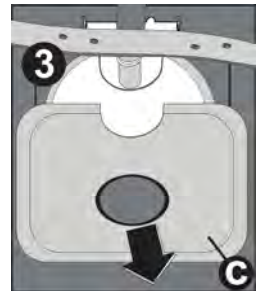

- Never use your dishwasher without any filter.
- Incorrect fitting of the filter will reduce the washing effectiveness.
- Clean filters are very important in terms of the proper running of the

machine.

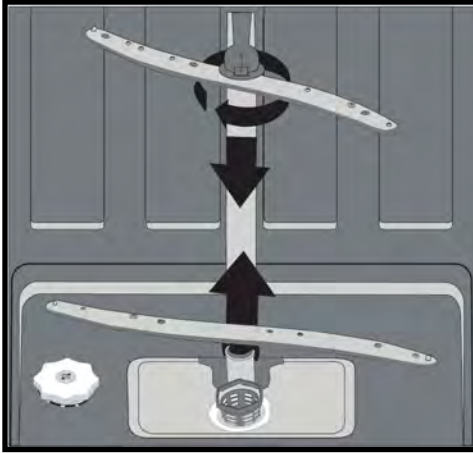

Spray arms

Check whether or not the holes for the upper and lower spray arms are clogged. If there is any clogging, remove the spray arms and clean them under water.











You can remove the lower spray arm by pulling it upwards, while the upper spray arm nut can be removed by turning the nut to the left.

Be sure that the nut is perfectly tightened when refitting the upper spray arm.

Hose filter

Water is prevented by the inlet hose filter so as to avoid any damage to your machine because of any contamination (sand, clay, rust etc.) that might be occasionally carried in through the mains water supply or the indoor plumbing, and to forestall such complaints as yellowing and formation of deposits after washing. Check the filter and the hose from time to time and clean them if necessary. To clean the filter, first turn off your tap and then remove the hose. After removing the filter from the hose, clean it under the tap. Insert the cleaned filter back into its place inside the hose. Refit the hose.

FAILURE CODES AND WHAT TO DO IN CASE OF FAILURE

ERROR CODE			ERROR DESCRIPTION	CONTROL
Wash /Dry	End	Start/Pause		
			Inadequate water supply	<ul style="list-style-type: none"> • Make sure the water input tap is totally open and that there is no water cut. • Close the water input tap, separate the water input hose from the tap and clean the filter at the connection end of the hose. • Restart your machine, contact the service if the error resumes.
			Error of continuous water input	<ul style="list-style-type: none"> • Close the tap. • Contact the service.
			The waste water in the machine cannot be discharged.	<ul style="list-style-type: none"> • Water discharge hose is clogged. • The filters of your machine might be clogged. • Power off-on your machine and activate the program cancellation command. • If the error continues, contact the service.
			Intended water temperature could not be reached faulty heater and heater sensor	Contact the service.
			Alarm is active against water overflow	<ul style="list-style-type: none"> • Power off your machine and close the tap. • Contact the service.
			Faulty electronic card	Contact the service.

If one of program monitor lights is on and start/Pause light is on and off,
Your machine's door is open, shut the door.

If the programme won't start

- Check if the plug is connected.
- Check your indoor fuses.
- Be sure that the water inlet tap is turned on.
- Be sure that you have closed the machine door.
- Be sure that you switched off the machine by pressing the Power On / Off button.
- Be sure that the water inlet filter and the machine filters are not clogged.

If the lamps "Wash/Dry" and "End" keep flashing

- Water overflow alarm is active
- Turn off your tap and contact an authorised service.

If the control lamps won't go out after a wash operation

The *Power On/Off* button is released yet.

If detergent residues are left in the detergent compartment

Detergent has been added when the detergent compartment was wet.

If water is left inside the machine at the end of the programme

- The water drain hose is clogged or twisted.
- The filters are clogged.
- The programme is not finished yet.

If the machine stops during a wash operation

- Power failure.
- Water inlet failure.
- Program can be on standby mode.

If shaking and hitting noises are heard during a wash operation

- Dishes placed incorrectly.
- Spray arm hitting the dishes.

If there are partial food wastes left on the dishes

- Dishes placed incorrectly into the machine, sprayed water did not reach related places.
- Basket overly loaded.
- Dishes leaning against one another.
- Very small amount of detergent added.
- An unsuitable, rather weak wash programme selected.
- Spray arm clogged with food wastes.
- Filters clogged.
- Filters incorrectly fitted.
- Water drain pump clogged.

If there are whitish stains on the dishes

- A very small amount of detergent is being used.
- Rinse aid dosage setting at a very low level.
- No special salt is being used despite the high degree of water hardness.
- Water softener system setting is at a very low level.
- Salt compartment cap not closed well.

If the dishes won't dry up

- A programme without a dry operation selected.
- Rinse aid dosage set too low
- Dishes unloaded too fast.

If there are rust stains on the dishes

- Stainless-steel quality of the dishes washed is insufficient.
- High rate of salt in the wash water.
- Salt compartment cap not closed well.
- Too much salt spilt into the sides and into the machine while filling it with salt.
- Unhealthy mains grounding.

Call an authorised service if the problem still persists after the controls or in case of any malfunction not described above.

PRACTICAL AND USEFUL INFORMATION

1. Whenever you will not be operating your machine
 - Unplug the machine and then turn the water off.
 - Leave the door slightly ajar in order to prevent the formation of unpleasant smells.
 - Keep the machine interior clean.
2. Eliminating water droplets
 - Wash the dishes with the intensive programme.
 - Take all of the metal containers in the machine out.
 - Do not add detergent.
3. If you properly place your dishes into the machine, you will be using it in the best way in terms of energy consumption, washing and drying performance.
4. Clean all rough waste before you place dirty dishes to the machine.
5. Operate the machine after it is completely full.
6. Use pre-washing program only when necessary.
7. Observe program information and average consumption values table when selecting a program.
8. Since the machine will reach high temperatures, it should not be mounted near refrigerator.
9. If the appliance is located in a place where the risk of freezing exists, you must completely drain the water that has remained in the machine. Turn off the water tap, disconnect the water inlet hose from the tap and allow the interior water to drain.

